

SX12D4

12" DVC Subwoofer



1600W
PEAK POWER



12"
WOOFER



4 OHM
IMPEDANCE



DUAL
VOICE COIL

SPECIFICATIONS:

Peak Power: 1600W
RMS Power: 800W
Voice Coil: 3"
Impedance: 4 Ohms
Magnet: 70 oz. x 2

FEATURES:

Die-Cast Aluminum Basket
Non-Pressed Paper Cone
Stitch Foam Surround

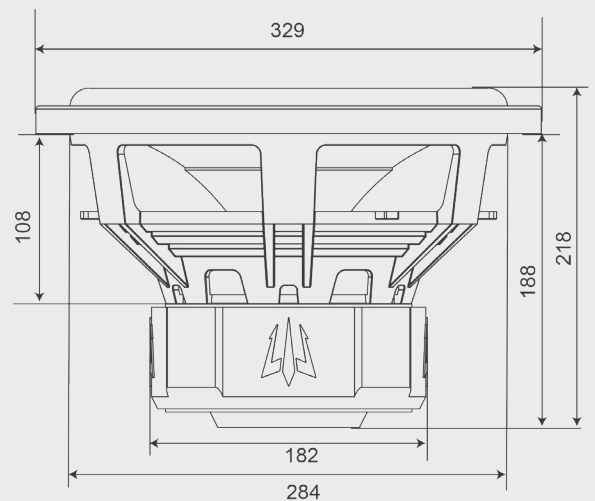
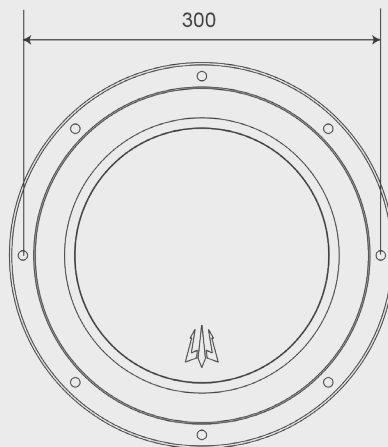

	SX6D2 Parallel Coils	SX6D2 Series Coils	SX8D2 Parallel Coils	SX8D2 Series Coils	SX10D2 Parallel Coils	SX10D2 Series Coils	SX12D2 Parallel Coils	SX12D2 Series Coils	
Electrical Parameters									
Re	1.07	4.27	1.03	4.1	0.99	3.94	0.98	3.9	Ohm
Le	0.827	3.302	1.081	4.346	1.117	4.499	1.092	4.391	mH
L2	1.262	5.008	1.832	7.3	2.088	8.341	2.008	7.973	mH
R2	2.1	8.31	2.91	11.48	3.49	13.95	3.41	13.53	Ohm
Cmes	2507.88	655.59	2471.38	611.31	3386.49	849.39	4244.45	1057.23	µF
Lces	5.25	19.47	5.75	23	4.83	19.26	4.41	17.58	mH
Res	10.39	46.18	11.22	47.59	11.21	44.39	9.57	39.28	Ohm
fs	43.9	44.5	42.2	42.4	39.4	39.4	36.8	36.9	Hz
Mechanical Parameters (using laser)									
Mms	133.918	140.509	243.816	236.71	355.654	354.712	428.618	432.956	g
Mmd (Sd)	132.068	138.659	240.714	233.608	349.171	348.229	414.794	419.132	g
Rms	5.138	4.641	8.792	8.137	9.367	9.407	10.555	10.427	kg/s
Cms	0.098	0.091	0.058	0.059	0.046	0.046	0.044	0.043	mm/N
Kms	10.17	11.01	17.14	16.83	21.76	21.68	22.89	23.29	N/mm
Bl	7.307	14.64	9.933	19.678	10.248	20.435	10.049	20.237	N/A
Lambda s	0.216	0.225	0.067	0.047	0.055	0.046	0.014	-0.003	
Loss factors									
Qtp	0.704	0.753	0.661	0.659	0.814	0.812	0.921	0.92	
Qms	7.184	8.474	7.353	7.757	9.392	9.322	9.385	9.631	
Qes	0.741	0.784	0.674	0.668	0.828	0.827	0.96	0.957	
Qts	0.672	0.718	0.618	0.615	0.761	0.76	0.871	0.87	
Other Parameters									
Vas	2.6848	2.4812	3.1734	3.232	6.6795	6.703	17.4253	17.1278	l
n0	0.029	0.027	0.034	0.036	0.047	0.047	0.087	0.087	%
Lm	76.88	76.5	77.52	77.71	78.95	78.97	81.59	81.57	dB
Lnom	79.59	73.2	80.4	74.59	82.01	76.02	84.69	78.67	dB
Sd	138.93	138.93	196.07	196.07	320.47	320.47	530.93	530.93	cm²
EBP	59.2	56.8	62.6	63.5	47.6	47.6	38.3	38.6	